

READ THESE ENTIRE INSTRUCTIONS BEFORE STARTING ANYTHING

2024+ GM 2500 AT4X TRUCK 4" LIFT KIT INSTRUCTIONS (PART #52454)

* This kit will not work on vehicles with factory auto ride suspension.

* Will work with factory 20" & larger wheels.

* Will work with aftermarket 18" & larger wheels, with maximum 5.75" backsacing.

Spindles are shipped with protective coating on surface. This allows them to be delivered to you without rust.

We recommend you clean and paint the parts before you install, to protect against any future rust.

Remember, spindles are bare metal. And will rust without paint.

AT4X



1. Lift Spindles (2)

2. Rear U-Bolts (4)

3. Rear Lift Blocks (2)

4. Rear Leaf Shims (4)

5. Passenger Side Diff Drop
Bracket

6. Drive Side Diff Drop Bracket

7. Large Cut-Off Template

8. Small Cut-Off Template

9. Skid Plate

10. Front AT4X Shock Mounts (2)

11. AT4X Shock Mount Hardware

12. Leaf Spring Center Pins (2)

13. Hardware Bag

14. Passenger Side "NTD" Bracket

15. Driver Side "NTD" Bracket

16. Driver Side Front Brake Line Bracket
(Frame Side)

17. Passenger Side Front Brake Line
Bracket (Frame Side)

18. Lower A-Arm "NTD" Puck/Spacer (2)

19. Vacuum Line Extension

20. Front Sway Bar End Links (2)
(11.5" Long, Stud to Stud)

21. Rear Crossmember

22. Front Crossmember



McGAUGHYS
S U S P E N S I O N P A R T S

559-226-8196
4603 E. VINE AVE.
FRESNO, CA 93725
www.mcgaughys.com

**READ THESE ENTIRE INSTRUCTIONS
BEFORE STARTING ANYTHING**

- If you are the installer only, and not the owner of the vehicle, please make sure the owner of the vehicle gets these instructions. They contain very important information about the lift kit, maintenance, and warranty.
- Before moving forward with installation, please layout all parts from boxes and ensure everything is present. If any parts are missing, please contact McGaughy's Suspension immediately at 559-226-8196.
- If you alter the finish of any of the provided components, like zinc plating, chroming, or powder-coating, which can cause damage to the strength and structure of the metal, any warranties will be null and void.
- If any components are ground on or modified in any way, then no returns or exchanges will be accepted and any warranties will be null and void.
- NO welding is required to install any part of this lift kit. Do not weld any components.
- Over-sized tires and heavier wheels can cause premature wear on factory and aftermarket components like ball joints, bushings, tie-rod ends, wheel bearings, idler arms, drive-lines, etc.... You may need to replace / install new components sooner than factory recommendations based on the tires and wheels you choose. Please note that the heavier and wider wheels and tires combined with aggressive driving (off-road and on highways) will cause more wear on ALL moving parts, factory and aftermarket. Especially when vehicle is in 4wd or Auto-4wd / AWD modes.

WARRANTY INFORMATION

- McGaughy's warrants all **McGaughy's** products against manufacturer's defects in materials or workmanship for a period of **ONE-YEAR** from the date of original purchase. All McGaughy's spindles carry a **LIFETIME** warranty against manufacturer's defects.
- Warranty will not extend to any product or part there in, that has been improperly installed, abused, or neglected.
- Any warranty will be void on lift kits or components that are installed along with another company's components. All McGaughy's parts are designed to work with factory components or other McGaughy's components only.
- McGaughy's will not warranty any product(s) that were modified in any way. Check fit all products prior to custom painting, powder-coating, or any form of fabrication (sanding, drilling, painting, chroming, etc).
- There are **NO WARRANTIES** neither expressed nor implied for powder-coating on any McGaughy's products.
- McGaughy's is not responsible for damages and/or warranty of other vehicle parts (factory or aftermarket) related or non-related to the install of McGaughy's component(s).
- Warranty is limited to the repair or replacement (of McGaughy's product only), at McGaughy's discretion. And only after inspection of the defective part, once returned to McGaughy's with proof of purchase, date of purchase, and all shipping costs prepaid.
- Any cost of labor, freight, incidental or consequential damages are expressly excluded from warranty.

FRONT INSTRUCTIONS: (Be sure to read the entire instructions before you start)

1. Place wheel chocks behind the rear tires. With the parking brake set, use a jack and lift the front of the vehicle and place jack stands under the frame on each side.



2. Remove the factory skid plate if your your vehicle has one. Not all of the models will have a skid plate. (pic 1)
3. Take a note on where the bolts are (how many threads are showing) on the torsion keys. This will be where you need to re-install them at later. (pic 2)
4. Unload both torsion key bolts. Remove the bolts completely. Use a torsion removal tool clamp to remove the threaded blocks on both sides to remove pressure on the suspension. (pic 3)

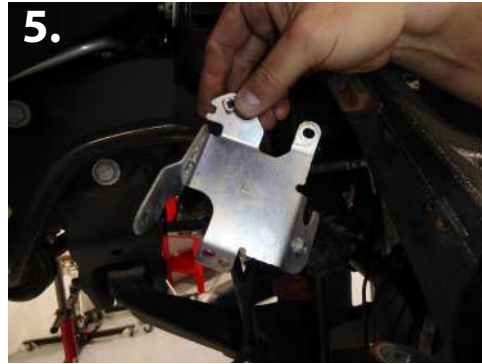

5. Remove tie rod ends from spindle using 21mm socket.
6. Disconnect brake lines and any electrical wires that are attached to the spindles.
7. Remove the brake line/abs wire factory steel bracket. You will NOT re-use this bracket. (pic 4-5)
8. Disconnect the caliper from the spindle using 21 mm socket. Secure caliper out of the way. Do not let caliper hang by the brake hose. You could cause the hose to tear, rip, or fail. (pic 6)

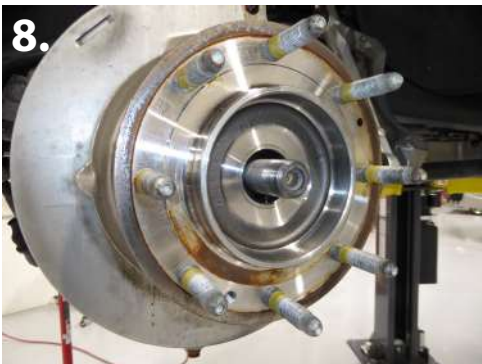

9. Remove the dust cap. (pic 7)
10. Remove keeper bolt and remove rotor. (pic 8)
11. Remove CV axle nut using 36mm socket. (pic 8)
12. Using 21mm socket, remove the four bolts from the back of the spindle to remove the bearing. Because of the tight fit, loosen with socket first then remove by hand. (pic 9)



10.



11.



12.

13. Remove upper ball joint nut using 18mm socket. (pic 10)

14. Use a 24mm socket to remove the lower ball joint nut. (pic 11)

15. Now remove factory spindles from the vehicle.

16. Disconnect and remove the factory sway bar end links using 18mm socket. These will NOT be re-used. (pic 12)

17. Remove the upper and lower shock bolts using 21mm socket and remove from vehicle. You will NOT re-use the factory shocks.



13.



14.



15.

18. Remove the factory torsion bars by pushing the bar through the A-arm to the front of the vehicle. Be sure to hold on to the factory torsion key because it will fall. Set keys aside, they will be use again. (pic 13)

19. With the torsion bar still inside the A-arm, un-bolt and remove lower A-arms from the vehicle. Now remove torsion bars from the lower A-arms. Make sure not to mix them up. They must go back in facing the same way and on the same side they came out.

20. Using 18mm socket, remove the CV axles from the vehicle. (pic 14-15)



16.



17.

21. Using 18mm socket, remove the factory rear crossmember. (pic 16)

22. Remove the four bolts and clamps that are mounting the front drive line. Set them aside, you will re-use them. Next, secure the front drive line out of the way. (pic 17)

23. Now use a jack to support the differential. Be sure to keep differential upright when removing from vehicle.



18.

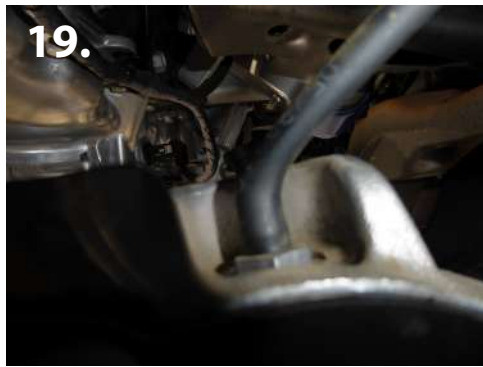

19.



20.

24. Disconnect the plug on the passenger side of differential. (pic 18) Also disconnect the three plastic clips on the differential. And the vacuum line on the top of the differential. (pic 19)

25. Use 18mm socket to remove the bolt on the driver side top of differential. (pic 20)



21.



22.



23.

26. Remove the bolt on the driver side bottom front of the differential using 15mm socket. (pic 21)

27. Use 18mm socket to remove the bolt on driver side bottom rear of differential. (pic 22)

28. Use 21mm socket to remove the bolt on the passenger side bottom front and rear. (pic 23)

29. Once all the lines and hose are disconnected and out of the way, drop and remove the differential. Be sure to keep it up right, as it is full of fluid.



24.

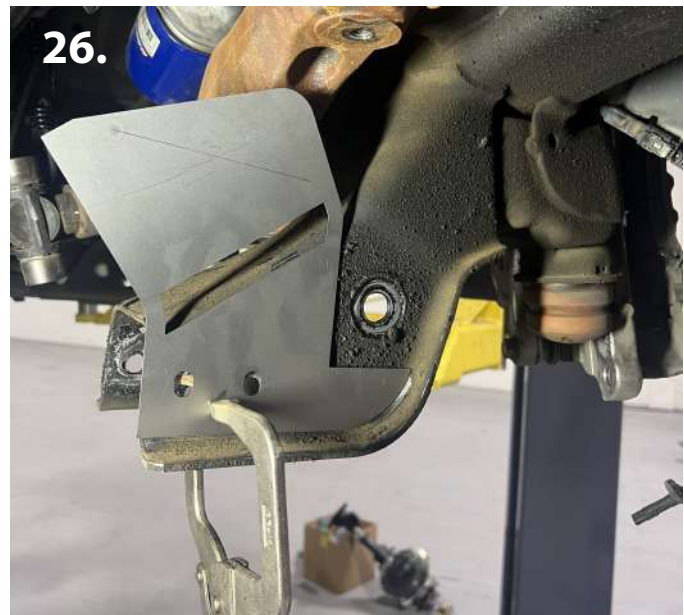

26.

30. Start on the driver side (pic 24). Line up the supplied cut-off template holes to the factory holes and clamp in to place (pic 26).



31. Next, bend template to curve on the driver side lower A-arm pocket where the new rear crossmember will mount (pic 27). Once bent over, clamp in to place (pic 28).



32. Now, use a scribe, and mark where to cut along the clamped template. (pics 29-30).

33. Once marked, you can remove the template and cut along the traced line. Or you can leave the template in place and use it as a guide to cut. (pic 31).

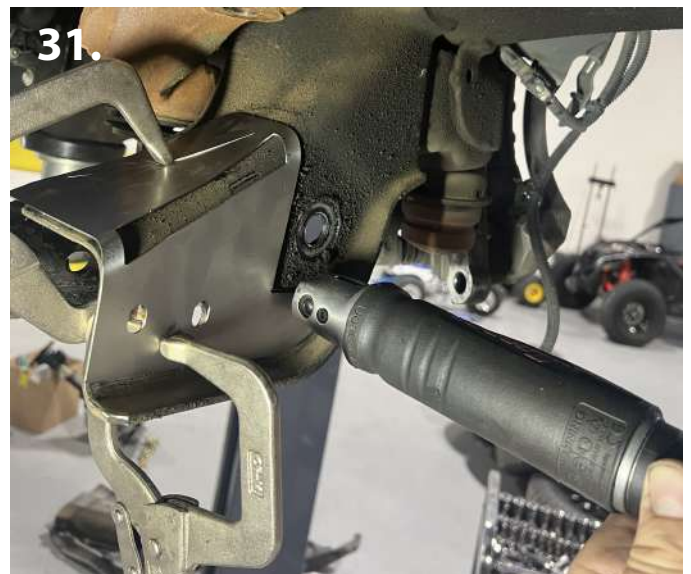



34. Remove cut piece and template (pics 32-33).

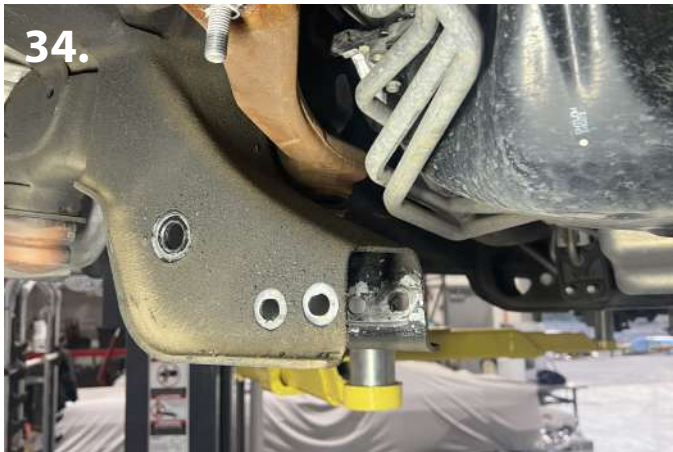

35. Next, move to the passenger side lower a-arm pocket (pic 34).

36. Line up and clamp the supplied cut template holes to the factory holes (pic 35). Now, use a scribe, and mark where to cut along the clamped template or you can leave the template in place and use it as a guide to cut.

37. Remove the cut piece and template (pic 36).





38. Install the driver side differential drop bracket using the supplied M12 x 30mm bolts and washers. Snug bolts only. Do not fully tighten (pic 37).

39. Install the passenger side differential drop bracket using the factory nuts and washers. Snug nuts only. Do not fully tighten (pic 38).



40. Using a jack for support, bolt up the differential. Start on the driver side. Use 1/2" x 3-3/4" bolts, washers, and lock nuts (pic 39). Snug bolts only. Do not fully tighten.

41. Now bolt the passenger side of differential to the drop down bracket using 1/2" x 1-1/2" bolts, washers, and lock nuts (pic 40). Snug bolts only.

42. Now that all bolts are installed and snug. You can start to tighten them up. Start on the driver side bolts on top of the diff drop bracket. Next tighten the passenger side nuts at the top of the diff drop bracket. Then tighten the driver side bolts attaching the differential to the drop bracket. Lastly, tighten the passenger side bolts attaching the differential to the drop bracket.

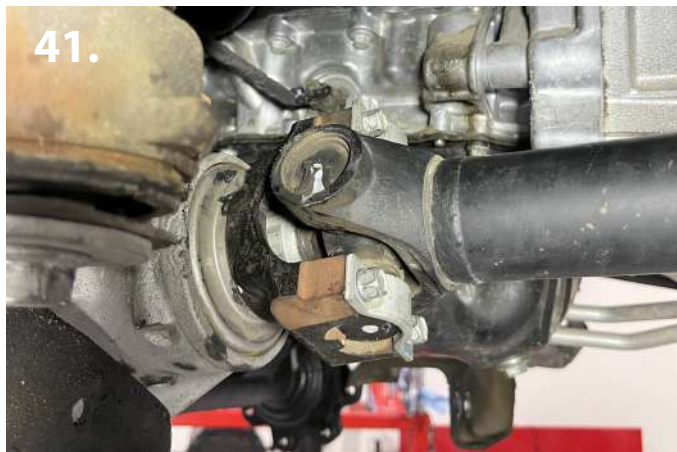

43. Reinstall the factory front drive line using the factory hardware. Be sure to use Loctite on all the bolts and torque to factory specs. (pic 41)



44. Install the supplied vent line extension on top of the differential housing. Then attach the factory vent line to the new extension using the supplied fitting (pic 42).

45. Reconnect plug on passenger side of differential (pic 43).

46. Reconnect the factory clips on differential. Use the supplied zip ties to secure in place (pic 44). Make sure the wires are not stretched or rubbing against anything, causing them to be cut or frayed.



47. Install the front crossmember in the original lower a-arm location, using the factory lower a-arm hardware (pic 45). Snug only, do not fully tighten bolts.

48. Now install the rear crossmember in the original lower a-arm location, using the factory lower a-arm hardware (pic 46). Snug only, do not fully tighten bolts.

49. Next, install the factory lower a-arms in to the new front and rear crossmembers. Use the provided M18 x 120mm bolts, washers, and lock nuts on the front crossmember. And the M18 x 130mm bolts, washers, and lock nuts on the rear crossmember (pic 47). Snug only, do not fully tighten bolts.

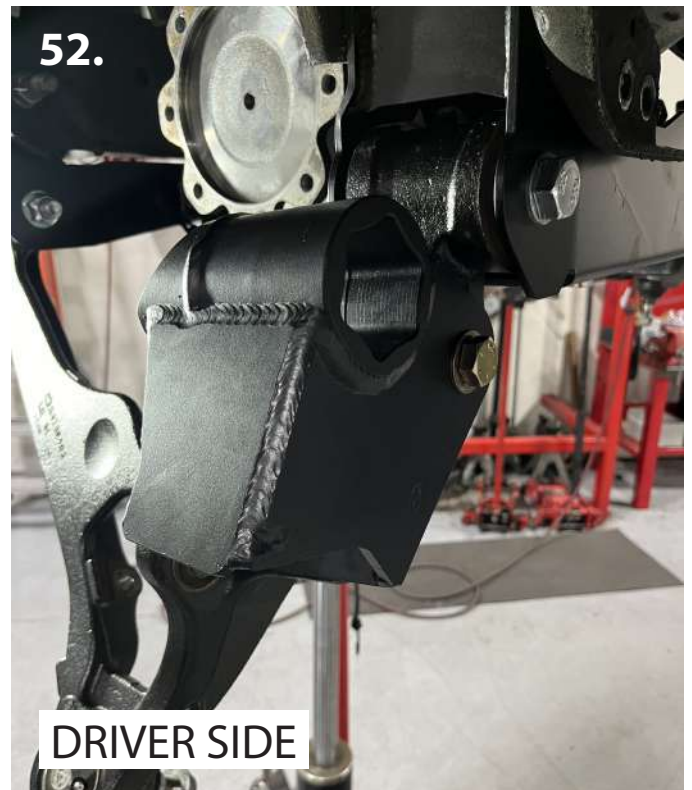
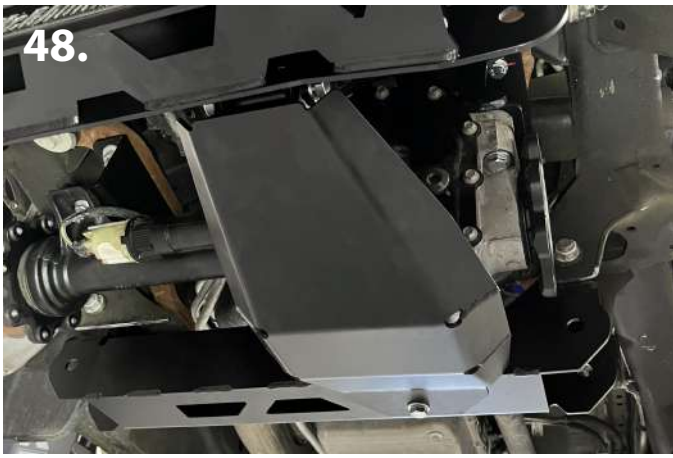

50. Install the provided skid plate to the front and rear crossmembers (pic 48).
51. Use the provided 1/2" x 4" bolt, washers, and lock nut on the front crossmember (pic 49). And the 1/2" x 1" bolt and washer (pic 50). Snug only, do not fully tighten bolts.
52. With everything installed and snug. You can now tighten the bolts. Start by tighten the upper bolts on both crossmembers. These are the where the crossmembers are mounted to the frame in the factory A-arm mounts. Next tighten the lower A-arm bolts on both sides. Be sure to hold the lower A-arm up as to mimic where it will be at ride hieght, and not just hanging. Lastly, tighten the bolts on the skid plate.

53. Insert the provided "NTD" (No Torsion Drop) puck spacer into the lower a-arm. Spacer fits inside where the factory torsion bar used to go (pic 51).



54. Now install the NTD bracket on to the lower a-arm. NTD bracket will slide over the install puck spacer. Use the 5/8" x 6" GR8 bolt. Bolt will go through the puck spacer on the lower a-arm (pics 52-53).

55. Be sure to push the NTD bracket completely forward on to the lower a-arm. With NTD in place, mark the ONE hole on the lower a-arm (pic 54).

56. With the hole marked, remove the NTD bracket and drill the marked hole using a 3/8" drill bit.

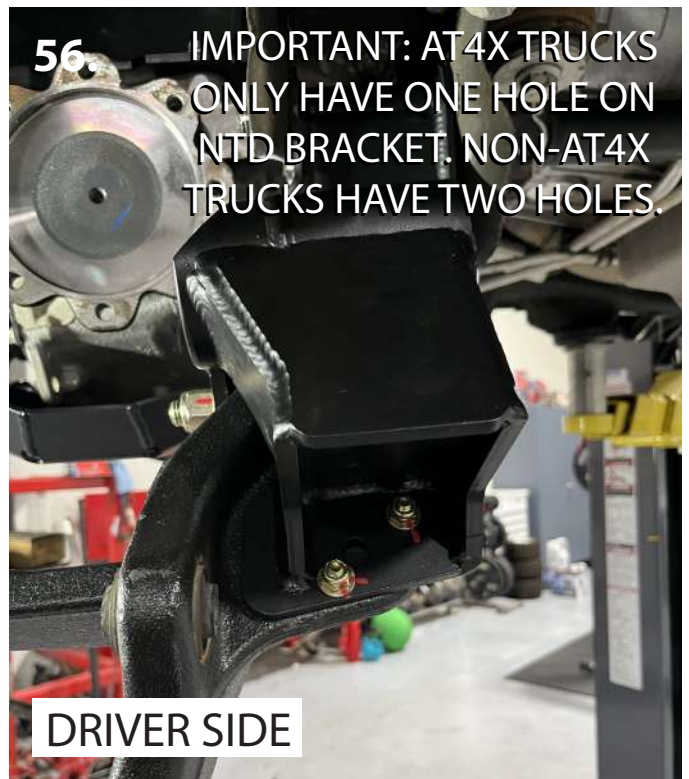

57. With the hole drilled, reinstall the NTD bracket on to the lower a-arm. Use the 5/8" x 6" GR8 bolt, washers, and nylon lock nut (pic 55). And 3/8" x 1-1/2" GR8 bolt, washers, and nylon lock nut in the hole that was drilled out on the lower a-arm (pic 56). Be sure to tighten the 3/8" bolt first, then tighten the 5/8" bolt last.

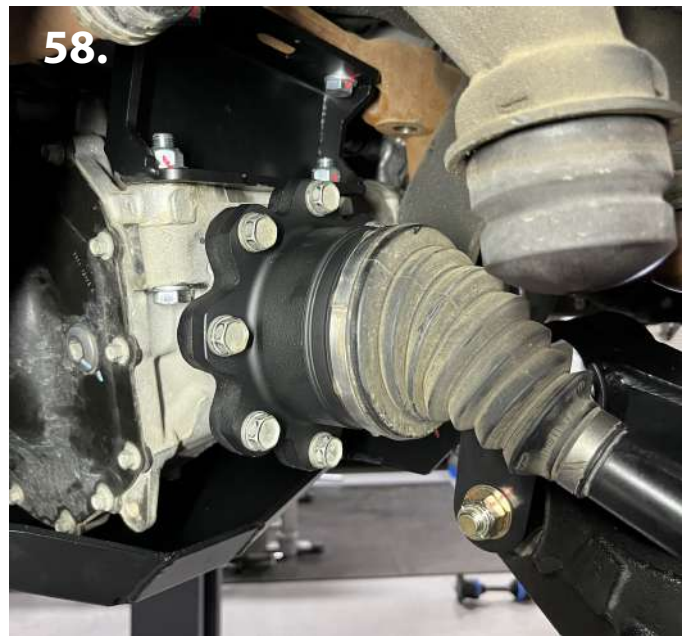
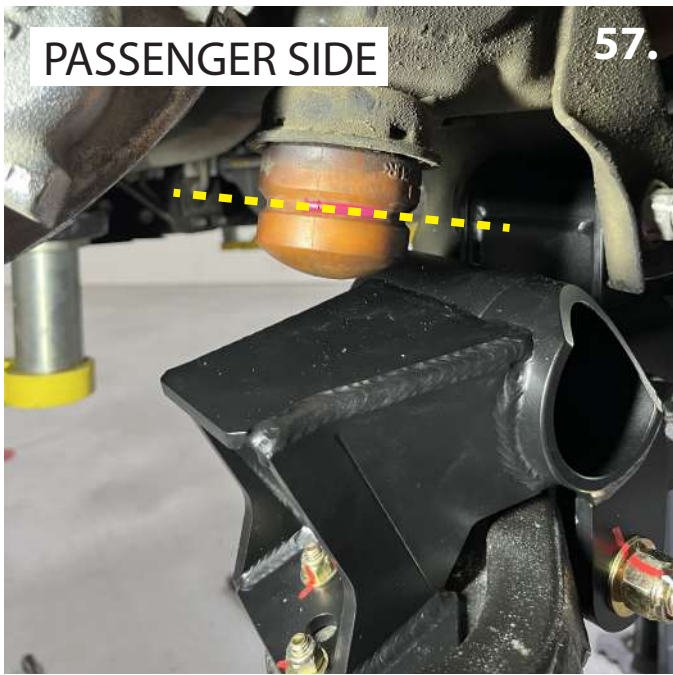

58. We recommend that you cut down the factory bump stop. We recommend that it be cut at the first rib (marked with the yellow dotted line) (pic 57).

59. Reinstall the factory CV axle using the factory bolts. Be sure to use Loctite on all the bolts (pic 58).



60. Now install the new lift spindles. Bolt up the upper and lower A-arms using the factory hardware. Torque to the factory specs (pic 59).

61. Make sure you remove the factory o-ring from the original spindles and reinstall on the new lift spindles (pic 60).



62. Reinstall the the factory hub on to the new spindles. Use the factory hardware. Be sure to use Loctite on each bolt. Torque to the factory specs (pic 61).

63. Reinstall CV axle nut. Be sure to Loctite and torque to factory specs. Reinstall rotor using the factory hardware. Torque to factory specs. Reinstall the calipers using the factory hardware. Be sure to Loctite each bolt. Torque to factory specs. (pic 62)

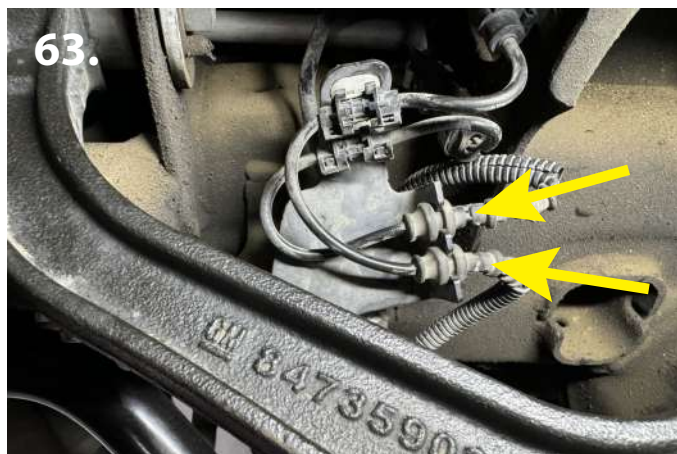

64. Before installing brake line brackets, these two wire connections on the driver's side need to be switched (yellow arrows). Unclip them from the factory bracket and swap their positions. Put the top one in the place of the bottom and the bottom line will go in the top location on the bracket (pic 63).

65. Now install the brake line extender bracket on to the frame. Driver side and passenger side brackets are different (driver side shown). Connect the extender bracket to the frame in the factory location just under the upper a-arm mount using the factory hardware. Install the factory bracket to the new extender using the provided 5/16" x 3/4" bolt, washers, and nut (pic 64).

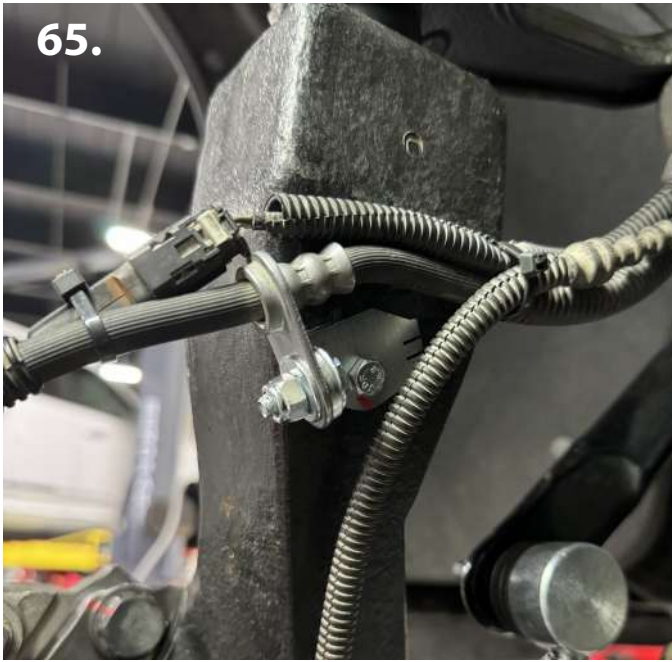

66. Next, install the brake line extender bracket on to the new lift spindles. Driver side and passenger side brackets are different (driver side shown). Connect the extender bracket to the spindle in the existing hole on the back. Use the supplied M6 x 10mm bolt on the back of spindle. Then, install the factory bracket to the new extender using the provided 1/4" x 3/4" bolt, washers, and nut (pic 65).

67. Use the supplied adel clamp to secure the brake line in the existing hole on the back of the spindle. Use the provided M6 x 10mm bolt on back of spindle (pic 66).



68. **THIS IS VERY IMPORTANT**, now that all the brake lines are in place and secure. Turn/rotate the spindle left to right fully. Make sure nothing is being over extended or stretched. Make sure nothing is rubbing or making contact with any part of the frame or suspension. You do not want any wires or hose to vibrate and be worn through. Make sure everything is in secure and in place 100% (pic 67).

VERY IMPORTANT: You will be re-using the factory Multimatic DSSV shocks. But you will be swapping sides and turning them around. Meaning, you must run the driver side shock on the passenger side, and vice versa. The shocks will also be orientated so the logo faces inwards. This is done to clear the spindle. If you do not do this, then the shocks will come into contact with the spindles and fail.

DRIVER SIDE

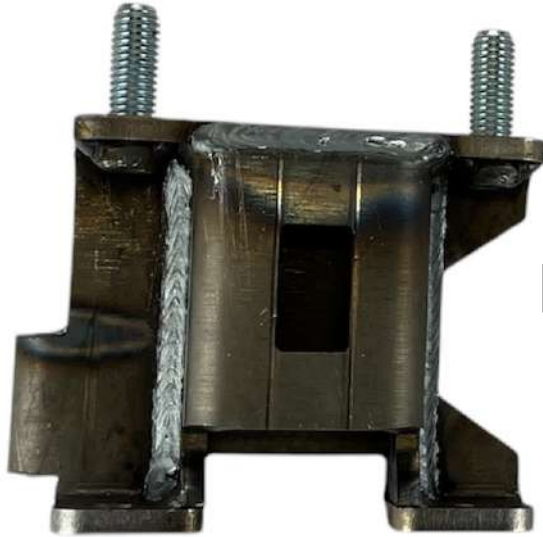

THIS SIDE
FACES OUT
TOWARDS
THE TIRE

PASSENGER SIDE

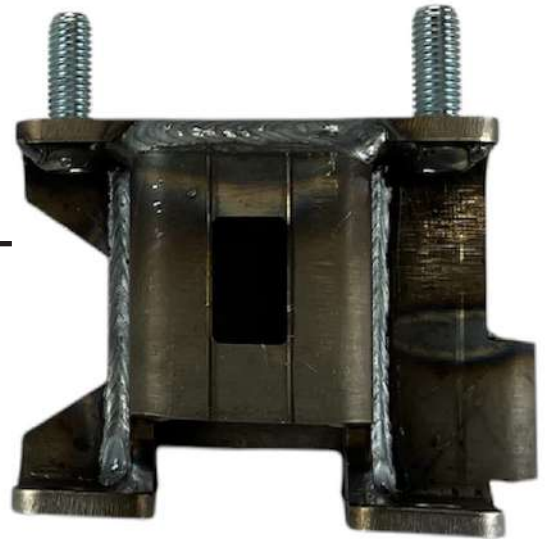

DRIVER SIDE



THIS SIDE
FACES IN
TOWARDS
THE
ENGINE

PASSENGER SIDE





69. First you will install the AT4X shock brackets onto the vehicle in the factory shock location. Be sure to use the provided 16g washers on top of the bracket on the two studs. These washers MUST be used. (pic 68-69)





70. Make sure to use the provided 1/4" thick washer on top of the bracket on the two studs. Use the provided top lock nut and tighten. (pic 70-72)

71. With the bracket bolted into place, use a scribe and mark the hole on the side of the bracket that needs to be drilled out. (pic 73-74)

72. After you mark the hole to be drilled, remove the shock bracket from the truck. Next, center punch the hole and drill out to 1/2". (pic 75)



73. You can now install the shock bracket on to the factory AT4X shocks. Use the factory nuts and torque to the factory specs. Make sure you swap sides. Pic 76 and 77 are the same shock. This is the "new / now" passenger side shock. Pic 76 is the way you will see it on the vehicle. It is the side that faces out towards the tire. Pic 77 is the inside. It is the side that will face inside towards the engine. *Please note: the Multitmatic Logo will now face inside towards engine.



78.



79.



80.

74. You can now install the shock and bracket back onto the truck. Remember to use the two 16g washers from pics 68 and 69 onto the bracket before installing in place. Also, be sure to use the 1/4" thick washers on top of the bracket and the two lock nuts. (pic 78)

75. You will also use the provided 1/2" x 1-1/4" bolt along with **THREE** washers and lock nut. in the hole that was scribed and drilled in step 72. One of the washers will act as a spacer and go between the bracket and frame. (pic 79). The other washers will install as normal. One on the bolt head side and one on the nut side. (pic 80)

76. With the upper mount completely installed and torqued to specs. Go ahead and connect the factory shock to the factory location on the lower a-arm. Use the factory hardware and torque to factory specs. (pic 81)

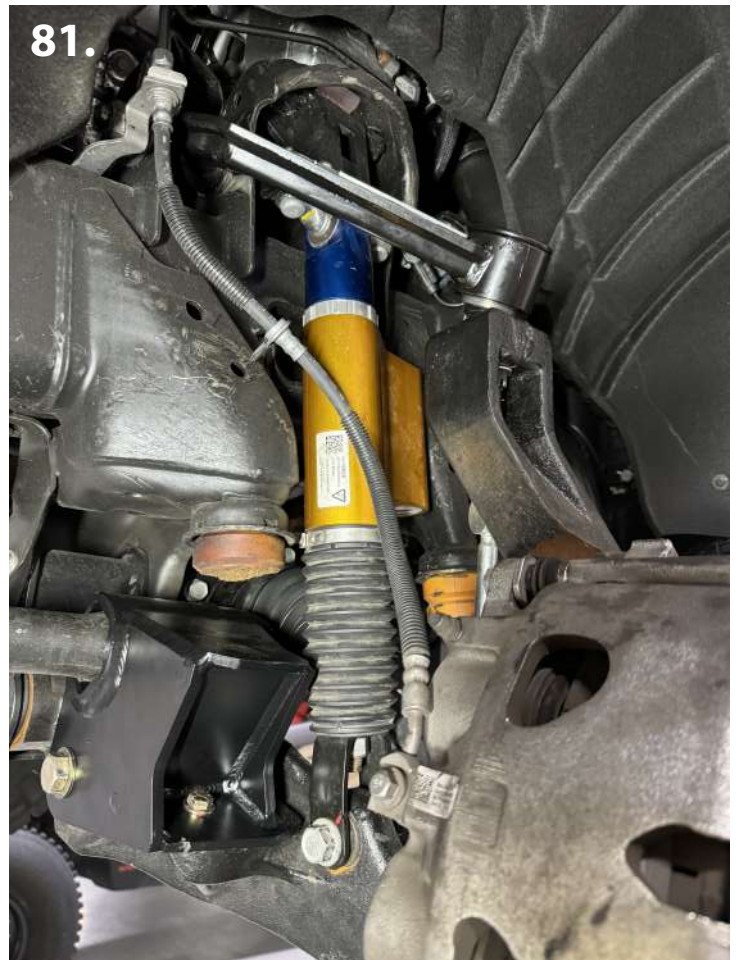

81.



77. Install the new provided sway bar end links. New end links will now mount inside the lower a-arm. NOT on the outside like the factory ones were (pic 82).



78. Reinstall the factory outer tie rod end on to the new lift spindles. Torque to the factory specs (pic 83).



79. Before reinstalling torsion bars. Mark and drill a small indentation on the factory torsion key. This will keep the bolt from moving around on the key. Measure 1" from the end of key and mark the key in the center. Use a 5/8" drill

bit and drill down into the key just deep enough so that it is tapered approximately 3/16" deep. NO MORE. (pics 84-85)



80. Re-install the torsion bars in to the new location in the NTD brackets on the lower a-arms. Be sure to install the torsion bars the exact same way they came out of the truck. Do not swap sides or turn around. You may have to lift up on the lower a-arm so that the torsion bar can pass through the NTD brackets easier (pic 86-87).

81. Using a key clamp, install block and tighten up the bolt on the torsion key (pic 88). Install both the driver side and passenger side. Make sure the bolt is centered on the torsion key, sitting in the indentation you made.

82. Tighten bolt to where it was when originally removed.



REAR INSTRUCTIONS:

83. Support the rear end with a jack and stands.

84. Remove the factory rear shocks. Save the hardware.

84. Start on one side and loosen the factory u-bolts. Do not remove full. Move to the opposite side and fully remove the factory u-bolts.

THIS KIT COMES WITH REAR SHIMS TO HELP LEVEL OUT THE TRUCK. IF YOU CRANKING UP YOUR TORSION KEYS IN THE FRONT TO GET MORE HIEGHT, THEN YOU WILL USE THE PROVIDED REAR SHIMS TO HELP LEVEL OUT THE TRUCK. THE SHIMS ARE OPTIONAL, AND ARE NOT REQUIRED TO BE INSTALLED. IF YOU ARE INSTALLING THE SHIMS, PROCEED TO THE NEXT STEP. IF YOU ARE NOT INSTALLING THE SHIMS, PLEASE SKIP TO THE NEXT PAGE, STEP 89.



85. With the u-bolts removed, drop the rear end a small amount and clamp both sides of the leaf pack (pic 89).

86. With the leaf pack secure, remove the factory center pin. Install the provided rear shims on to the new supplied center pin and install on to the leaf pack. Torque to specs (pic 90).

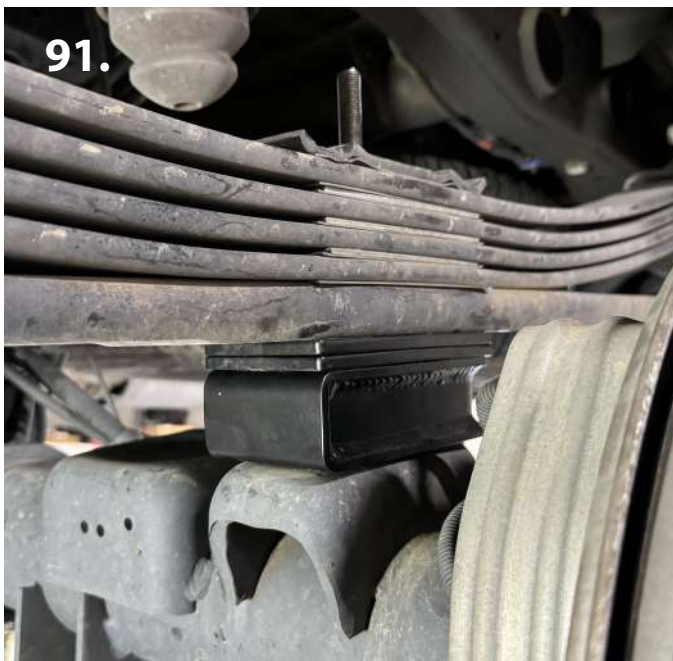

87. Remove clamps and place the provided lift blocks between leaf pack and rear end. Jack up rear end to keep blocks in place (pics 91-92). *NOTE: pic 91 is the front of the lift block, pic 92 is the back side/rear of truck.

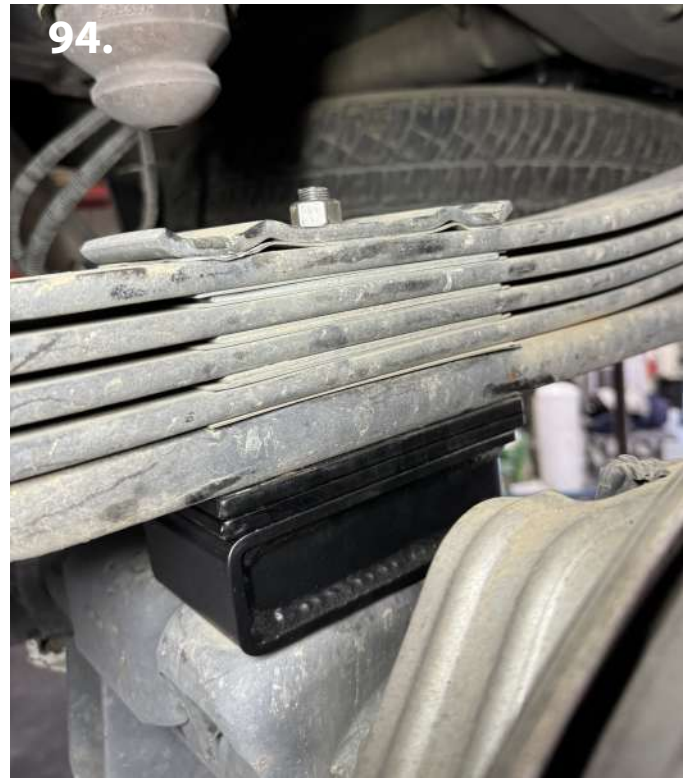

88. The provided center pin may be longer than you need. If so, you can trim the excess amount off. It is not necessary to cut the pin though. (pics 93-94)



89. Now install the provided u-bolts (pic 95). Only snug the nuts. Do not tighten. Repeat the steps on the opposite side next. Once both sides are installed, then tighten up all the u-bolt nuts. Torque to 190 ft lbs.



90. Now re-install the factory shocks. Shocks will install in the factory location using the factory hardware (pic 96).

- * Double check all of the front and rear fasteners and components, making sure everything has been torqued to the proper specifications. This MUST be done before operating the vehicle.**
- * Vehicle MUST be properly aligned before driving.**
- * After 500 miles, be sure to go over all of the front and rear suspension and lift components to make sure nothing has come loose and everything is still tight.**
- * We recommend periodically checking all of the front and rear suspension and lift components to be sure they are tight and in proper working order.**

HARDWARE	LOCATION	QUANTITY
M12-1.75 x 30mm HXHD 10.9 ZP	DS diff drop	2
M12 Flat Washer DIN 125A ZP	"	4
M12-1.75 Top Lock Nut ZP	"	2
1/2"-13 x 3-3/4" HXHD GR5 ZP	DS diff	2
1/2" SAE Flat Washer ZP	"	4
1/2"-13 Top Lock Nut ZP	"	2
1/2"-13 x 1-1/2" HXHD GR5 ZP	PS diff	2
1/2" SAE Flat Washer ZP	"	4
1/2"-13 Top Lock Nut ZP	"	2
M18-2.5 x 120mm HXHD 10.9 ZP	front x-mem	2
M18 Flat Washer DIN 125A ZP	"	4
M18-2.5 Top Lock Nut ZP	"	2
M18-2.5 x 130mm HXHD 10.9 ZP	rear x-mem	2
M18 Flat Washer DIN 125A ZP	"	4
M18-2.5 Top Lock Nut ZP	"	2
1/2"-13 x 4" HXHD GR5 ZP	skid plate	1
1/2" SAE Flat Washer ZP	"	2
1/2"-13 Top Lock Nut ZP	"	1
1/2"-13 x 1" HXHD GR5 ZP	"	1
1/2" SAE Flat Washer ZP	"	1
5/8"-11 x 6" HXHD GR8 YZ	NTD	2
5/8" Thru Hard Washer YZ	"	4
5/8"-11 Nylock Nut GR8 YZ	"	2
5/16"-18 x 1-1/2" HXHD GR8 YZ	"	4
5/16" Thru Hard Washer YZ	"	8
5/16"-18 Nylock Nut GR8 YZ	"	4
5/16"-18 x 3/4" HXHD GR5 ZP	brake lines	2
5/16" SAE Flat Washer ZP	"	4
5/16"-18 Nylock Nut GR5 ZP	"	2
1/4"-20 x 3/4" HXHD GR5 ZP	"	2
1/4" SAE Flat Washer ZP	"	4
1/4"-20 Nylock Nut GR5 ZP	"	2
1/2"-13 x 1-1/2" HXHD GR5 ZP	front shocks	4
1/2" SAE Flat Washer ZP	"	8
1/2"-13 Top Lock Nut ZP	"	4