

2014-18 DODGE RAM 2500
8" LIFT KIT #54320

The factory wheels and tires will fit on the vehicle once lift kit is installed, as long as they are 18" or larger.

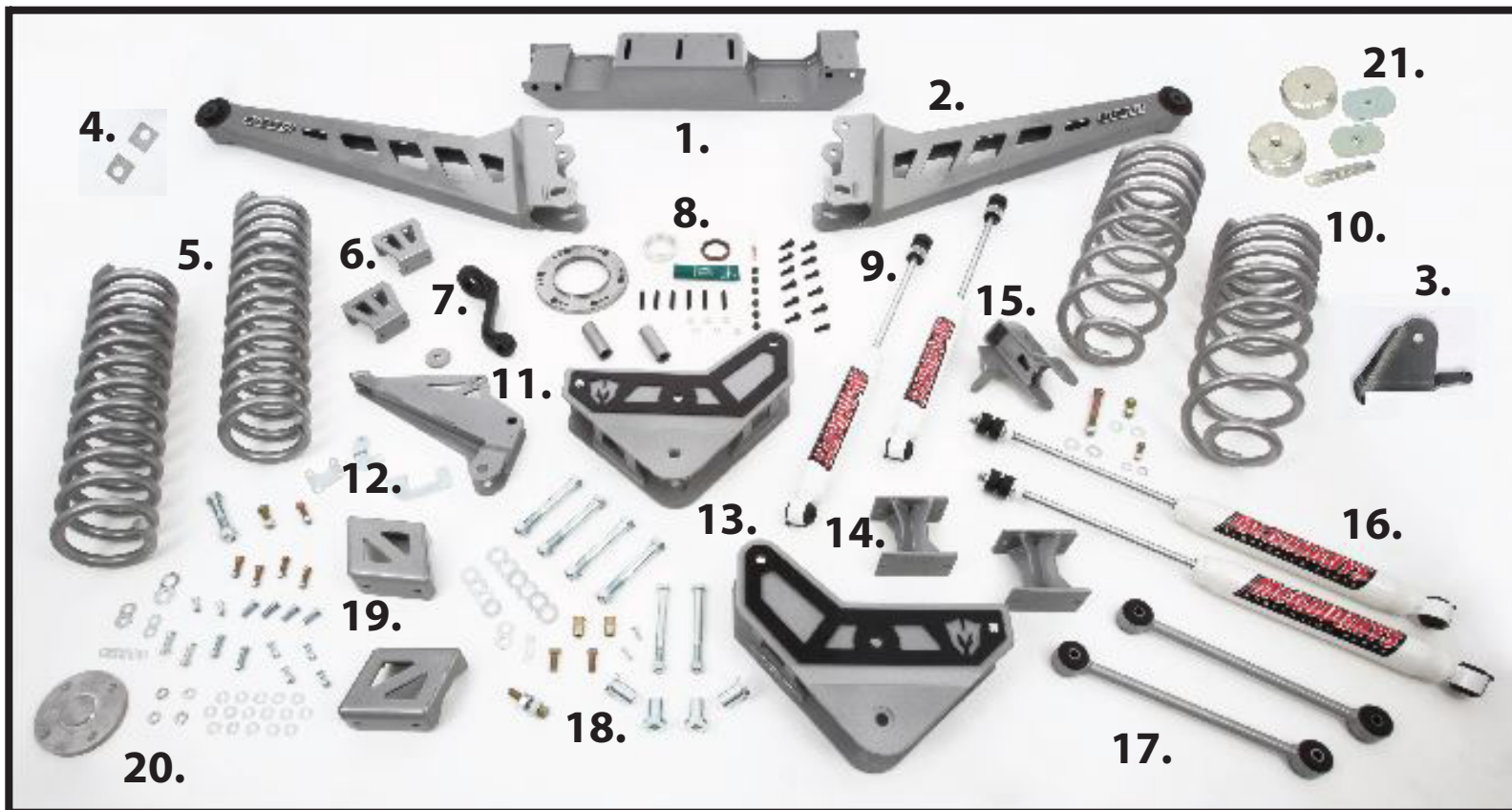

- | | |
|---------------------------------------|--------------------------------------|
| 1. Transmission Crossmember | 11. Front Track Bar Drop Bracket |
| 2. Radius Arms | 12. Brake Line Brackets |
| 3. Rear Track Bar Reinforcement Brace | 13. Radius Arm Drop Brackets |
| 4. Front Track Bar Alignment Cams | 14. Rear Bump Stop Drop Brackets |
| 5. Front Coil Springs | 15. Rear Track Bar Extension Bracket |
| 6. Front Bump Stop Drop Brackets | 16. Front Shocks |
| 7. Drop Pitman Arm | 17. Rear Sway Bar End Links |
| 8. Re-Clocking Ring Kit | 18. Hardware Packs |
| 9. Rear Shocks | 19. Front Sway Bar Drop Brackets |
| 10. Rear Coil Springs | 20. Front Driveline Spacer |
| | 21. Front Coil Retainer Kit |



McGAUGHYS
S U S P E N S I O N P A R T S

559-226-8196
4603 E. VINE AVE.
FRESNO, CA 93725
www.mcgaughys.com

**READ THESE ENTIRE INSTRUCTIONS
BEFORE STARTING ANYTHING**

- If you are the installer only, and not the owner of the vehicle, please make sure the owner of the vehicle gets these instructions. They contain very important information about the lift kit, maintenance, and warranty.

-Before moving forward with installation, please layout all parts from boxes and ensure everything is present. If any parts are missing, please contact McGaughy's Suspension immediately at 559-226-8196.

-If you alter the finish of any of the provided components, like zinc plating, chroming, or powder-coating, which can cause damage to the strength and structure of the metal, any warranties will be null and void.

-If any components are ground on or modified in any way, then no returns or exchanges will be accepted and any warranties will be null and void.

-NO welding is required to install any part of this lift kit. Do not weld any components.

-Over-sized tires and heavier wheels can cause premature wear on factory and aftermarket components like ball joints, bushings, tie-rod ends, wheel bearings, idler arms, drive-lines, etc.... You may need to replace / install new components sooner than factory recommendations based on the tires and wheels you choose. Please note that the heavier and wider wheels and tires combined with aggressive driving (off-road and on highways) will cause more wear on ALL moving parts, factory and aftermarket. Especially when vehicle is in 4wd or Auto-4wd / AWD modes.



McGAUGHY'S
S U S P E N S I O N P A R T S

559-226-8196
4603 E. VINE AVE.
FRESNO, CA 93725
www.mcgaughys.com

WARRANTY INFORMATION

- McGaughy's warrants all **McGaughy's** products against manufacturer's defects in materials or workmanship for a period of **ONE-YEAR** from the date of original purchase. All McGaughy's spindles carry a **LIFETIME** warranty against manufacturer's defects.
- Warranty will not extend to any product or part there in, that has been improperly installed, abused, or neglected
- McGaughy's will not warranty any product(s) that were modified in any way. Check fit all products prior to custom painting, powder-coating, or any form of fabrication (sanding, drilling, painting, chroming, etc).
- There are **NO WARRANTIES** neither expressed nor implied for powder-coating on any McGaughy's products.
- McGaughy's is not responsible for damages and/or warranty of other vehicle parts (factory or aftermarket) related or non-related to the install of McGaughy's component(s).
- Warranty is limited to the repair or replacement (of McGaughy's product only), at McGaughy's discretion. And only after inspection of the defective part, once returned to McGaughy's with proof of purchase, date of purchase, and all shipping costs prepaid.
- Any cost of labor, freight, incidental or consequential damages are expressly excluded from warranty.

FRONT INSTALLATION

Always use the proper tools and consult the factory service manual for torque values and procedures. With the vehicle turned off and the parking brake set, secure the rear wheels/tires with wheel chocks. Use a jack and lift the front of the vehicle. Place jack stands under the frame on both side of the vehicle. Remove the front wheels.

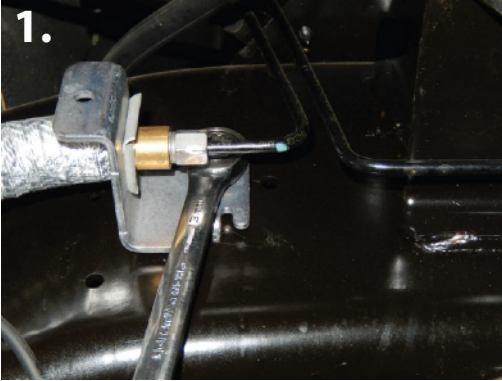

1. Using a 13mm wrench, unbolt the brake line brackets from the frame. Also, unbolt the brake line bracket from the front axle for extra maneuverability. (pic 1)

2. Support the front driveline with a suitable strap, and remove the four flange bolts using a 15mm socket. (pic 2)

3. Remove the driver's side drag link to pitman arm nut using a 21mm socket. Use a tie-rod removal tool to avoid any damage to the stock tie-rod end. (pic 3)

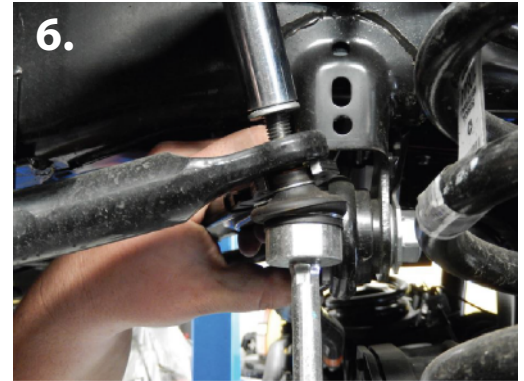

4. Using a 46mm socket, remove the pitman arm to steering box nut. (pic 4)

5. Using a pitman arm puller, remove the pitman arm from the steering box output shaft. (pic 5)

6. Remove the sway bar end link top nuts only, using a 18mm socket. (pic 6)

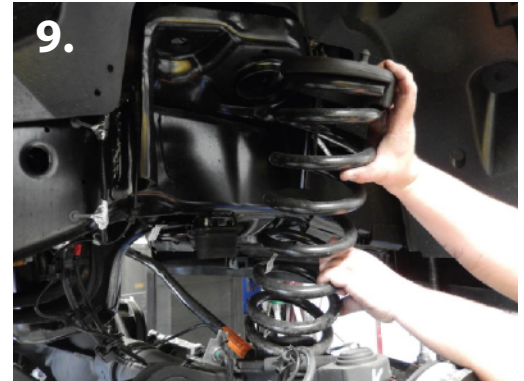

7. Using a 15mm socket, remove the sway bar mounts from the frame. (pic 7) You can remove the sway bar completely from the vehicle now.

8. With the front axle supported, remove the front shocks from the vehicle. Use a 21mm wrench on the top nut and 21mm socket on the lower nut. (pic 8)

9. Now slowly lower the front axle to release the front coils. Remove the factory coils from the vehicle. (pic 9)

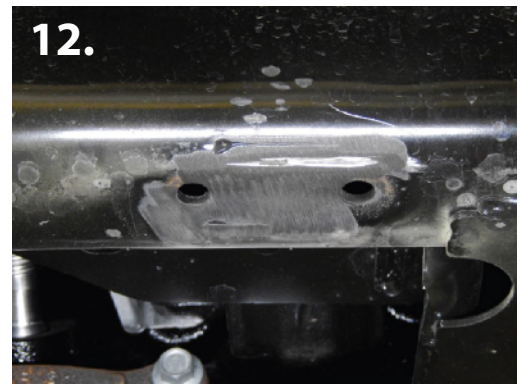
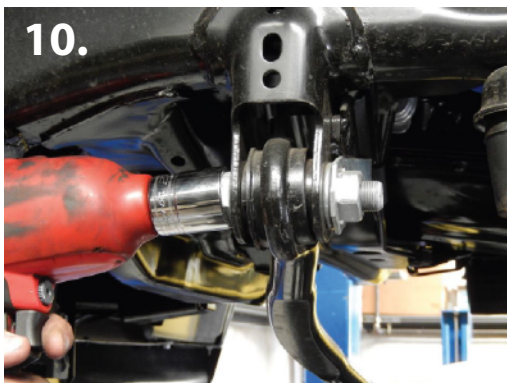

- 10. Remove the front track bar from the factory mount on the frame, using a 27mm socket. (pic 10)
- 11. Use a cut off wheel to remove the front bump stop mounts on the frame. The bump stop mounts will be reused, so do not destroy them. Cut the welds only. (pic 11)
- 12. Clean the frame of any remaining weld material and make smooth. Once clean, be sure to paint the bare metal so that it does not rust. (pic 12)

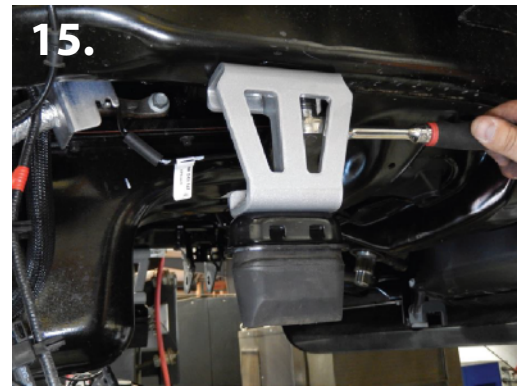
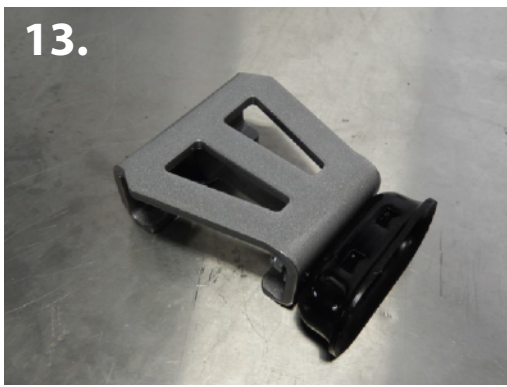

- 13. Now install the factory bump stop mounts you just cut off the frame onto the new bump stop drop brackets. Use the supplied 3/8" button head allen bolts, washers, and lock nuts. (pic 13)
- 14. Reinstall the factory bump stops into the factor mounts you just bolted on. (pic 14)
- 15. You will have to tap the holes on the frame where the factory bump stop mounts were removed. Use the provided tap, and tap the holes to 7/16". Once tapped, install the new bump stop assemblies onto the frame using the provided 7/16" x 3/4 hardware. (pic 15)

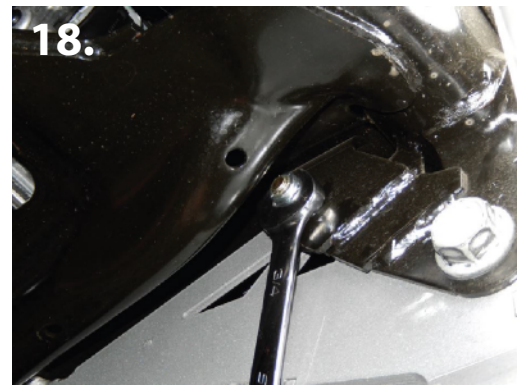

- 16. Install the new track bar drop bracket into the factory track bar mount using the factory bolt. With the new drop bracket held up against the frame, drill out the hole for the brace to 7/16". (pic 16)
- 17. The top hole will need to be drilled out to 1/2", if your vehicle does not have a factory hole. Some vehicles already had a factory hole in this location. (pic 17)
- 18. Use the provided hardware to install the new track bar drop bracket. 1/2" x 1-1/2" bolt from the rear, with washers and lock nut, on the top hole. (pic 18) And use the provided 7/16" x 1-1/2" grade 8 hardware for the lower brace.

19. Remove the factory radius arms from vehicle. Use a 27mm socket for the front upper bolt and a 24mm socket and 27mm wrench on the lower bolt. The back frame mount bolt will be removed using a 27mm socket as well.



20. Insert the provided frame spacers into the factory hole on the frame. (pic 19)
21. Install radius arm drop down brackets using the provided 5/8" x5-1/2" bolt through the inserted frame spacer. Use provided metric 18 x 130mm for the center hole. (pic 20)



22. Center punch through the drop brackets onto the frame to mark where to drill. (pic 21) Then remove the drop brackets and drill the frame to exactly 43/64". Do not make any bigger, or insert nut will not catch properly. Start with a smaller drill bit and work up.

23. Once the hole is drilled, use a rivet tool (pic 22) to install the insert nut into the frame. You may have to tap it into the hole. Properly tighten with impact. (pic 23-24)



24. Insert the provided spacer into center of the radius arm drop bracket. Use the metric 18 x 130mm hardware to hold in place. (pic 25)

25. Use the provided 1/2"-13 x 3/4" bolt in the hole your drilled and installed the insert nut. (pic 26)

26. Now tighten the other two bolts on the drop down bracket. (pic 27)





28.



29.

27. Install the new provided radius arms onto the vehicle. Axle side, top bolt first. Use the factory hardware. (pic 28) Use the provided metric 18 x 130mm bolt to install the new radius arms into the new drop down brackets. (pic 29) And lastly, the axle side lower bolt. Using the factory bolt with the cam washer.

You must align the vehicle before driving.

28. You can now reconnect the factory track bar into the new track bar drop bracket. Use the provided 18mm x 90mm hardware. Do not fully tight track bar yet. Just snug.

29. Make sure the track bar alignment cams are installed with the hole towards the outside tire. (pic 30) Be sure to use both cams, one on the front of the track bar bracket and one on the back. Make sure the cams are aligned as shown and the bolt can pass through with no obstructions.

***** Before moving forward, Please refer to coil retainer instructions *****



30.

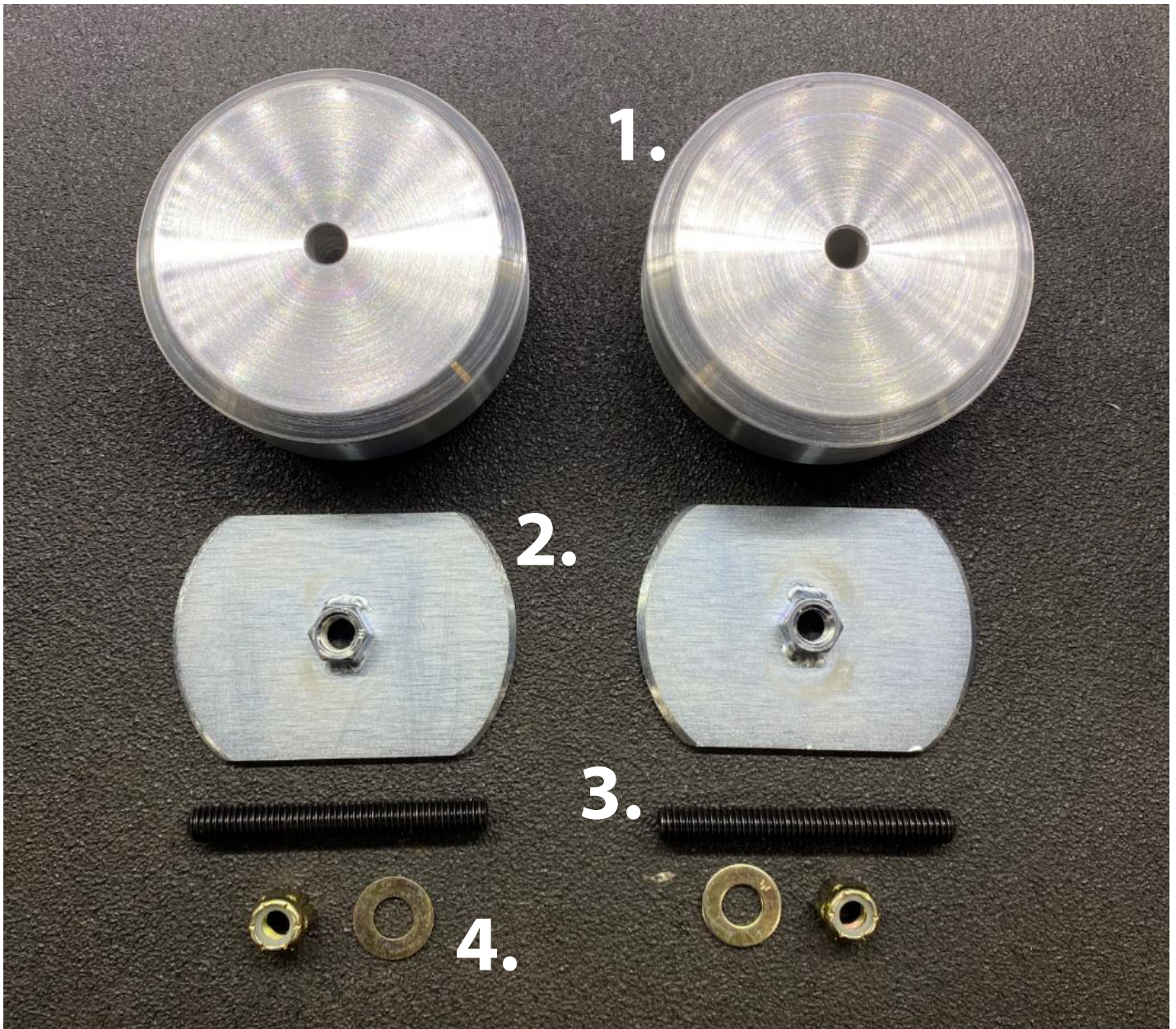

Kit Includes:

1. Coil Retainer Billet Pucks (2)
2. Retainer Backing Plate (2)
3. Retainer Bolt (2)
4. Hardware - Lock Nut (2) / Washer (2)



1. First apply loctite to the supplied retainer bolt. Then screw bolt into the retainer backing plate. Make sure bolt is flush with the top of the welded nut only. Do not screw the bolt past the backing plate.



2. Next, insert the backing plate with bolt into the opening on the factory upper coil mount.



6.



3. With the backing plate installed, slide the supplied billet coil retainer puck in place. Make sure the billet puck slides into place in the opening on the mount. You may need to clean the edges of the opening with a file or sand paper, to be sure a nice tight fit. Then use the supplied washer and lock nut to install. Use an allen wrench and a 9/16" wrench to tighten to 20 ft/lbs.

4. Now re-install the factory coil isolator into the factory location.

5. Repeat these steps for the opposite side of the vehicle.

Now with the coil retainer pucks installed, you can now install the new provided lift coils.
DO NOT install front coils without having the billet coil retainer pucks installed



30. Install new provided coils into the factory location. Be sure to use the factory coil isolator on top of the new lift coils. Coils and isolator install into the factory location. (pic 31)

31. The new coils will install with the tighter windings towards the top and the more open windings towards the bottom. (pic 32)

32. Install the new provided front shocks. Use the supplied new hardware for the upper mount and the factory hardware for the lower mount. (pic 33)

33. You can now tighten all the hardware on the front track bar and track bar drop bracket. Torque to factory specs.

34.



35.

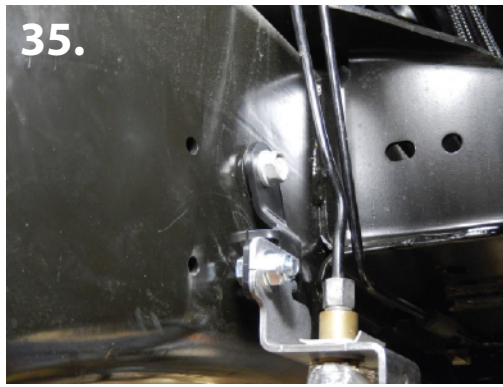

36.

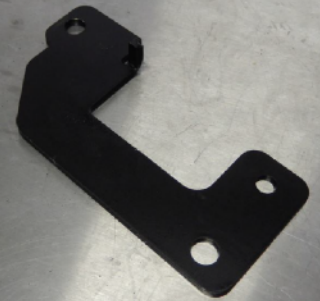

34. Install the provided brake line drop bracket on the driver side of the frame using the factory hardware. Then install the factory brake line bracket onto the new drop bracket using the supplied 5/16" x 3/4" hardware. (pic 34-35)

35. Now install the provided brake line drop bracket on the passenger side using the factory hardware. Install the factory brake line bracket onto the new drop bracket using the supplied 5/16" x 3/4" hardware. (pic 36)

36. You can now reinstall the driver side and passenger side factory brake line brackets into the factory location on the axle.

37.



38.

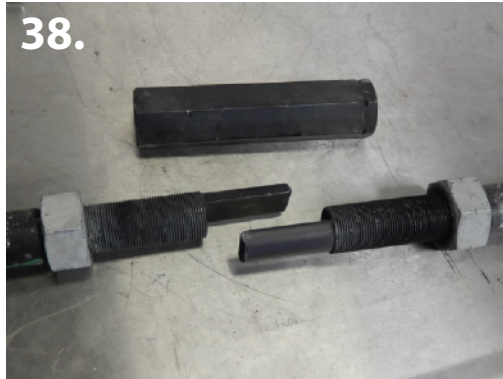

39.



37. Install the new drop pitman arm. Apply red loctite to the factory ptman arm retention nut and tighten to factory Specs. (pic 37) **Be sure to recheck this nut after first 500 miles.**

38. Loosen the drag link adjuster lock nuts. Turn the adjuster until the drag link is free.

39. Cut off the unthreaded portion of the drag link and end link. (pic 38-39) Reinstall end link back onto drag link.

40. Install drag link end back into the drop pitman arm from the bottom. Torque to factory specs. (pic 40)

40.



41.

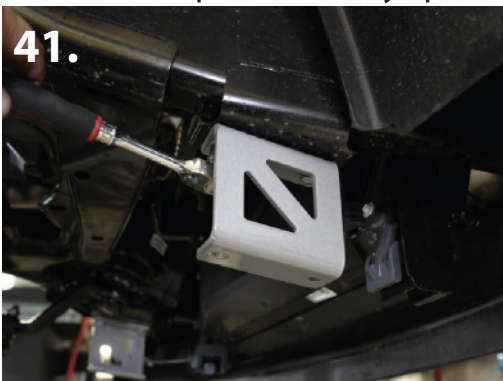

42.



41. Install the new sway bar drop into the factory location using the factory hardware. (pic 41)

42. Reinstall the factory sawy bar mounts onto the new drop down brackets using the provided 3/8" x 1-1/4" grade 8 hardware. (pic 42) You can now reconnect the sway bar end links to the factory sway bar.



43. This kit requires a transfer case reclocking ring (included). You will need to remove the original transmission crossmember from the frame. Once you have supported the transmission, one of the bolts on the passenger side cannot be removed because it will hit the exhaust, it must be cut. Remove the nut and push the bolt back through, exposing the head of the bolt. Cut the head of the bolt off and pull it back through the opposite way. (pic 43) We provide you a new replacement bolt to use. ***** Before moving forward, Please refer to reclocking ring instructions.*****

44. Install the new transmission crossmember. Use the remaining three factory bolts and the one new bolt to replace the bolt that had to be cut. (pic 44)

45. Install wire loom relocating bracket on the driver side rear of transmission crossmember. Use the factory clip to hold the wire loom in place. The clip will snap into the new loom bracket. (pic 45)
Torque all bolts to factory specs.



46. Reinstall the front drive line. Install provided driveline spacer between driveline and transfer case. Use the provided 7/16" x 14 x 2" hardware. Be sure to apply the provided thread lock to the bolts. Align drive shaft flange and axle flange and thread in bolts. Torque to factory specs. (pic 46)

REAR INSTALLATION

With the vehicle turned off and the parking brake set, secure the front wheels/tires with wheel chocks. Use a jack and lift the rear of the vehicle. Place jack stands under the frame on both side of the vehicle. Remove the rear wheels.



47. Support the rear end with a jack. Then remove the parking brake cable from the frame, located in the driver side wheel well. Next, remove the factory rear shocks using a 21mm socket and wrench.

48. Remove the nut on the axle bracket that holds on the parking brake. (pic 47)

49. Next, pull the brake line retaining clip. (pic 48)

50. Then remove the factory brake bracket from **9**, the rear axle using 9/16" socket. (pic 49)

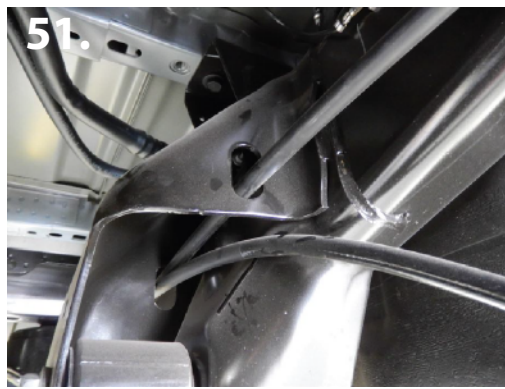

50. Undo the parking brake cable at the union. Squeeze the clip and pull cable through the cab mount. (pic 50)

52. Now, pull the parking brake cable through both holes in the cab mount and front leaf spring hanger. (pic 51) Re-route the cable back through the leaf



spring hanger front hole and skip the rear hole. Now reconnect cable at the union.

53. Remove the factory rear sway bar end links from the vehicle.

54. Remove the bolt holding the rear track bar on the rear end.

55. Now slowly lower the rear end so that the rear coils can be removed easily.

56. You will need to drill out the existing hole on the bottom of the factory track bar mount on the rear end. Drill the hole to 1/2".

(pic 52)

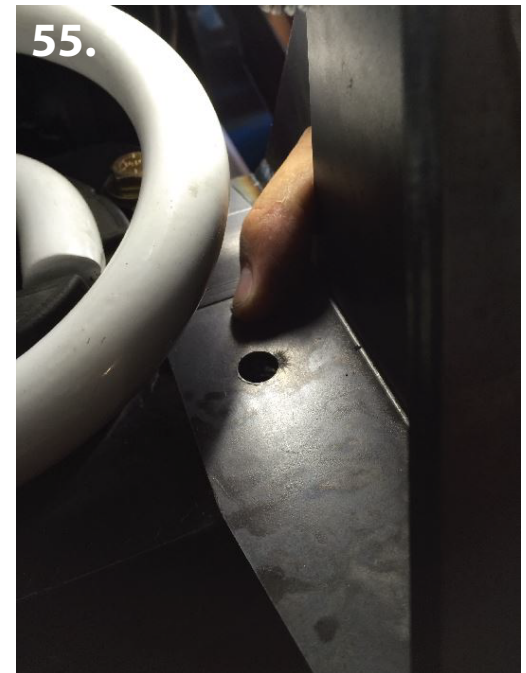

57. Install the new rear coil springs into the factory locations. Be sure to use the upper and lower coil spring isolators as well. Make sure you lift the rear end up to put pressure on the coils, so they do not fall out or shift.

58. Install the new rear track bar bracket into the factory track bar location. You use the factory track bar bolt in the factory location and into the new extension bracket. You will use the provided 1/2" x 1-1/2" hardware to bolt down the bracket in the hole that you drilled out previously. (pic 53)

59. You will install the new track bar brace against the new track bar extension bracket. The factory track bar will install into the new extension bracket using the provided 9/16" hardware. Make sure the bolt goes through both the extension bracket and the track bar brace.

60. The track bar brace will bolt in using the provided 3/8" x 1-3/4" hardware. Make sure you use the provided 1/4" thick washer between the factory coil mount and the brace bracket. (pic 54)

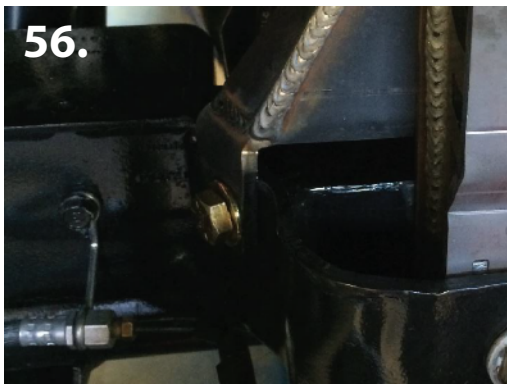

56.



57.

61. You will need to drill out the hole on top next to the hole on the coil mount to 3/8". Use the provided 3/8" x 1-1/2" hardware to bolt down. (pic 55)

62. You will also need to drill out the side hole for the brace to 1/2". Use the provided 1/2" x 1-1/2" hardware to bolt down. (pic 56)

63. You can now go through all the hardware on the track bar bracket and tighten down. (pic 57)



58.

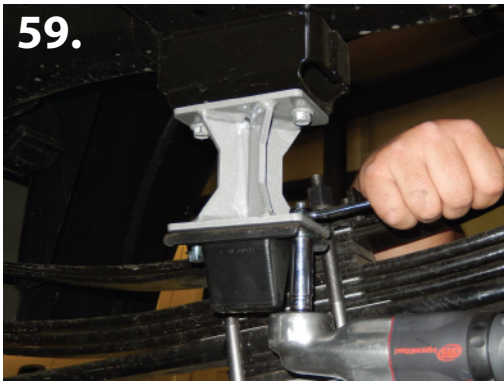

59.



60.

64. Install the factory coils into the factory upper coil pocket and on the new lower spacer mount. Make sure you are using the upper and lower coil isolators. Raise the rear end to keep pressure on the coils, so they do not fall out.

65. Install the new sway bar end links using the provided 1/2" x 2-1/2" hardware. Make sure you use the larger washer on the outside and the smaller washer on the inside. (pic 58)

66. Unbolt the factory bump stop from the frame. Install the new bump stop drop brackets onto the frame in the factory locations, using the factory hardware. Now bolt the factory bump stops onto the newly installed drop brackets. Use the provided 3/8" hardware. (pic 56)

67. Install the new rear shocks into the factory locations using the factory hardware. Make sure the body of the shocks are towards the ground. Torque to factory specs. (pic 60)



61.



62.



63.



68. Install the new provided brake line bracket onto the rear end, using the stock stud a 9/16" nut. (pic 61-62)

69. Mount the factory parking brake cable onto the stud on the new rear end bracket using the factory hardware. (pic 63)

70. Now install the brake lines onto the new brake bracket using the factory spring clip. (pic 64)

*** Double check all of the front and rear fasteners and components, making sure everything has been torqued to the proper specifications. This MUST be done before operating the vehicle.**

*** Vehicle MUST be properly aligned before driving.**

*** After 500 miles, be sure to go over all of the front and rear suspension and lift components to make sure nothing has come loose and everything is still tight.**

*** We recommend periodically checking all of the front and rear suspension and lift components to be sure they are tight and in proper working order.**

DODGE RAM RE-CLOCKING RING INSTRUCTIONS
2014-22 2500 / 2013-22 3500 (for 6", 8", & 10")



1. Place a jack under the transmission pan.

2. Using a 15mm socket, remove the three nuts that hold transmission mount to crossmember. (pic 1)

3. Use a 15mm socket to remove the bolts that hold the driveline to the rear differential. (pic 2)

4. Remove rear driveline from the transfer case. Place a rag under the output shaft so any light oil can be captured. (pic 3)

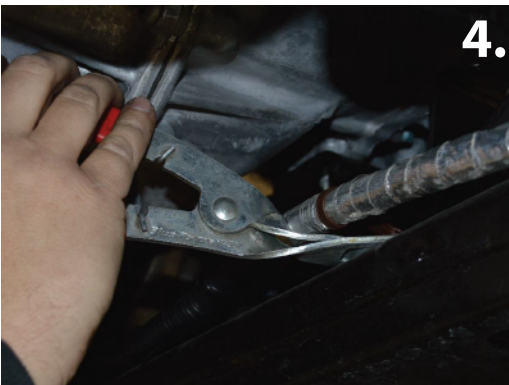

5. Remove the eight Christmas tree clips on the wire that routes along the transmission crossmember. (pic 4)

6. Remove the 4 bolts that hold the transmission crossmember to the frame, using a metric 24 socket and wrench. (pic 5)

7. Remove the transmission crossmember from the vehicle. (pic 6)



8. Remove the front drive line bolts from the transfer case using a 5/8" wrench. Remove the drive line from the vehicle using a 15mm socket. (pic 7)

9. Remove the rubber transmission mount from the transmission using a metric 15 socket. (pic 8)

10. Unplug the electrical connector on the transfer case. (pic 9)

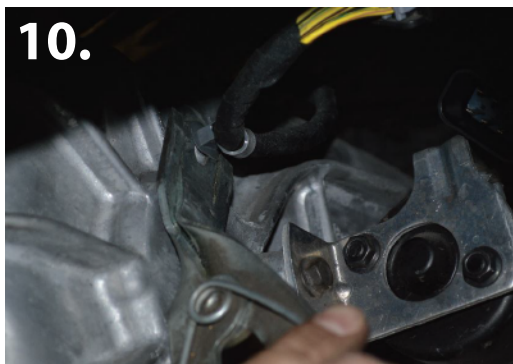

11. Remove the 3 Christmas tree clamps that hold the wire to the transfer case. (pic 10) And disconnect the vent tube using pliers.

12. Using a metric 14 wrench, remove the six nuts that hold the transfer case to the transmission. (pic 11)

13. Using an inverted torque, remove the factory studs from the transmission case and discard. You can use pliers if you do not have an inverted torque. (pic 12)



14. Take the index ring and locate the position where the bolt pattern matches up to the transfer case. (pic 13)

15. Using the provided metric 10-1.5 x 25mm SNCS bolts, tighten the ring to the transfer case. Apply a small amount of loctite to the bolts and tighten using a 8mm allen wrench. (pic 14)

16. Install the supplied 3/8"-24 x 2" S.S. screw using a 3/16" allen wrench. Apply a small amount of loctite to each screw. Be sure to only screw in until it touches, then put a small amount of pressure to tighten. Torque to 5 ft/lbs.



NOTE: Picture 16 shows in the **recommended** 20 degree position. You will need to install the McGaughy's transmission crossmember in this position. Picture 17 shows the 10 degree position, which can run the factory crossmember with trimming.

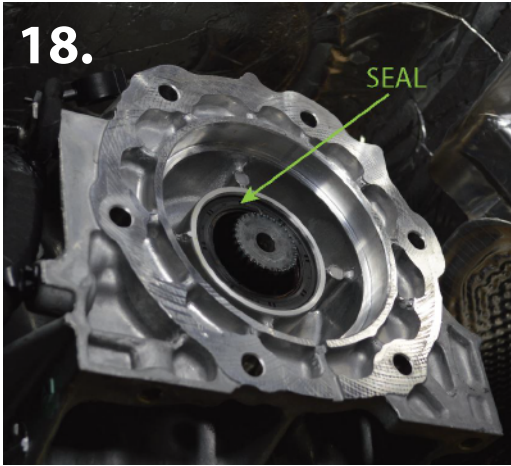

17. Remove the output shaft seal on the transmission and discard the factory seal. (pic 18)

18. Using a bearing race and seal driver, install the oil seal into the seal adaptor. (pic 19)

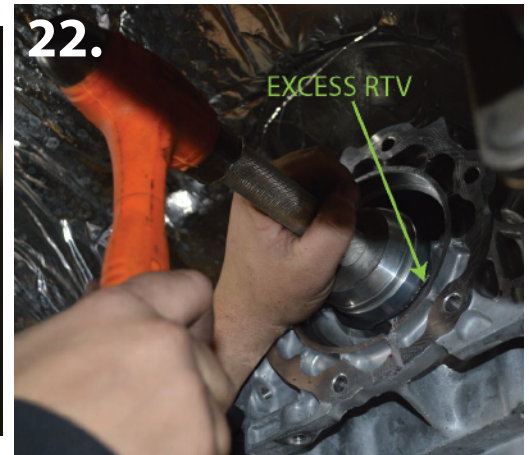
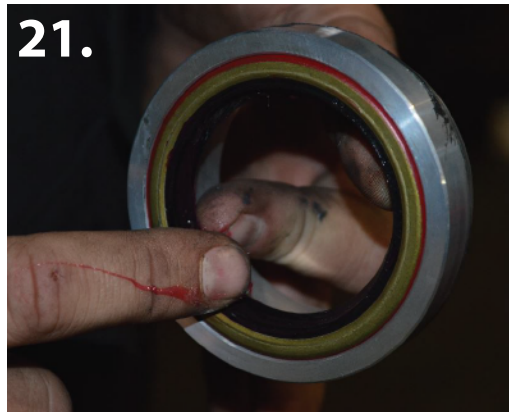
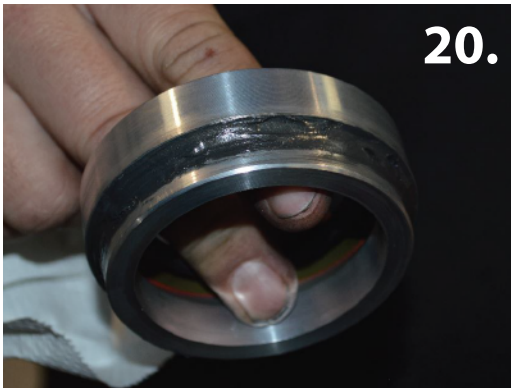

19. After the seal is installed, apply a small amount of RVT silicon to the seal adaptor. (pic 20) Also, apply a small amount of grease to the seal. (pic 21)

20. Tap the seal adaptor into the transmission where the factory seal was, using a bearing race and seal driver. Remove any excess RTV silicon. (pic 22)

BE SURE TO LET SILICON SET FOR 24 HOURS BEFORE DRIVING



21. Reinstall the transmission case to the transmission, using a 9/16" wrench and socket. Torque to factory specs. (pic 23)

22. Reconnect the vent tube to the vent port. Reinstall the electrical connector with the three Christmas tree clamps.

23. Reinstall the rubber transmission mount. Torque to factory specs. (pic 24)

24. Reinstall the front drive line. (pic 25)

25. If your kit came with a drive line spacer, install it now using the supplied 7/16" x 2" bolts. Use a small amount of loctite and a 5/8" wrench. (pic 26)

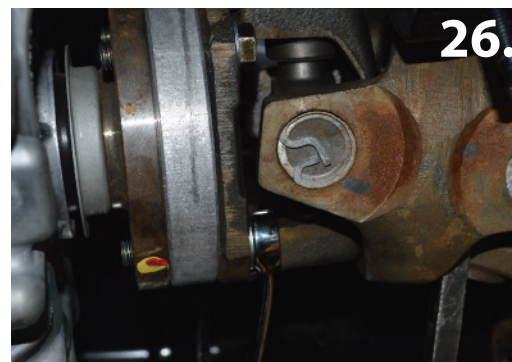

26. Install the McGaughy's crossmember with the large cut out on the driver side, using the factory hardware and a metric 24 wrench. (pic 27)

27. Reinstall the Christmas tree clamps using the holes provided in the crossmember.

28. Remove the clip that holds the electrical harness to the frame. (pic 28)

29. Make sure the wiring harness does not interfere with the drive line. (pic 29)

30. Now tighten the rubber transmission mount to the transmission crossmember using a metric 15 socket.